

Polygon Series

The Wall Wash

The Polygon series offers an interesting opportunity to create a statement in your space with a hanging luminaire system. Choose from multiple standard patterns or develop your own custom pattern of L23 fixtures.

The Wall Wash has specially designed brackets that allow for construction of a linear wall wash configuration. The popular L23 fixtures provide bright, white and energy efficient illumination with up and down lighting options. Revolutionize lighting in your space with an innovative and refreshing fixture.

CONSTRUCTION

Brackets are laser cut, fabricated, and robot-welded from 14-gauge powder coated cold-rolled steel with custom colors available.

OPTIONS

14W emergency battery backup integrated in all fixtures 4 foot long and above.

FLAIR

Customize the color of your brackets and/or end caps to add flair to your unique hanging luminaire system. Consult factory for more information.

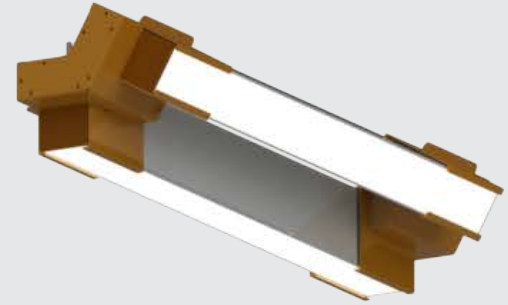

INDIVIDUAL FIXTURE DIMENSIONS

24" L23: 24"L x 2"W x 3"H

48" L23: 48"L x 2"W x 3"H

72" L23: 72"L x 2"W x 3"H

96" L23: 96"L x 2"W x 3"H

SPECIFICATIONS

- 4 standard fixture sizes – 24", 48", 72", and 96"
- 4 standard patterns with custom patterns available
- Customizable bracket, fixture, and end cap colors available
- Pendant mount for multiple ceiling types.
- Many lumen package / wattage options via programmable drivers
- Multiple Kelvin temperature options (3000K, 3500K, 4000K, 5000K)
- Emergency battery backup options available
- CRI >80 (90 available)
- >50,000 hrs of L70 LED life
- Rated for dry and damp locations
- 0 - 10 Volt dimmable 120-277V (120V ELV/TRIAC avail)
- Power factor >0.90
- 5 year warranty



ORDERING GUIDE

Factory at your fingertips. Fill in the blanks to create your part number or create a custom configuration.

Sample Part Number: PLY23-P-FR-6X27-LT-U12-D40-DMV-WH-30K-RD-EM14-WW

SERIES	MOUNTING	DIFFUSER	DIAMETER ¹	GEAR	WATTAGE & LUMENS* ²	
PLY23	P Pendant	FR Frosted	6X27 6.5"W x 27"L	LT	Up & Down	U12D40 Uplight 12W & 1380 Lumens, Downlight 40W & 4600 Lumens
						Down Only
					Up & Down	U24D80 Uplight 24W & 2760 Lumens, Downlight 80W & 9200 Lumens
						Down Only
			Up & Down		U36D120 Uplight 36W & 4140 Lumens, Downlight 120W & 13800 Lumens	
					Down Only	D120 Downlight 120W & 13800 Lumens
			Up & Down		U48D160 Uplight 48W & 5520 Lumens, Downlight 160W & 18400 Lumens	
					Down Only	D160 Downlight 160W & 18400 Lumens
			6X51 6.5"W x 51"L		6X75 6.5"W x 75"L	6X99 6.5"W x 99"L

DRIVER		FINISH ³		CCT ⁴		FLAIR ⁵		OPTIONS	
DMV	0-10V Dimming	WH	White	30K	3000K/>80 CRI	RD	Red	EM14	14W Emergency battery backup (integrated in fixtures 4 ft and up)
		BK	Black	35K	3500K/>80 CRI	BL	Blue		
DMV11	0-10V Dimming Separate drivers for uplight and downlight	SL	Silver	40K	4000K/>80 CRI	BK	Matte Black	-WW	Wall Wash
				50K	5000K/>80 CRI				

- Note:
- Wall wash configurations are measured by an overall system width and length.
 - Values shown are totals per system, minimum individual fixture wattage is 10W. Uplight only available on vertical fixture. Minimum 5W per fixture foot uplight and downlight. Maximum 7W per fixture foot uplight and 14W per fixture foot downlight. For uplight only, change the 'D' to 'U' in the Down Only sections. Power feed cable is 18AWG, power drop is required every 800W or 48 feet for 0-10V dimming, whichever comes first. EM not available in fixtures 4' and shorter if there is uplight and downlight.
 - Consult product catalog for more finish color options.
 - Consult factory for 90 CRI options.
 - NEW!** Personalize your lighting even further by choosing a standard flair color for your brackets, at no additional cost, from the guide on the following page.
 - HC912 hanging kit comes standard with PLY23 fixtures. Consult factory for other options.

*Programmable LED drivers allow custom configured wattages and corresponding lumens.

We reserve the right to change design, materials, LED's and finish in any way that will not alter installed appearance or reduce function and performance.

CATALOG#: _____
PROJECT: _____
TYPE: _____

STANDARD FLAIR BRACKET COLORS AND FINISHES



Gloss Black
(GB)



Matte Black
(BK)

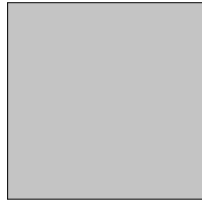

Matte Silver
(SL)



Statuary Bronze
(BZ)

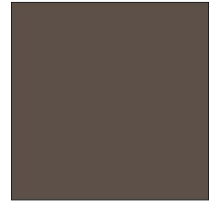

Glimmer (Iron)
(IR)

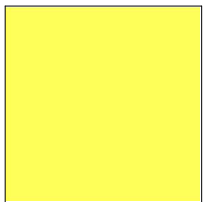

Safety Yellow
(YL)

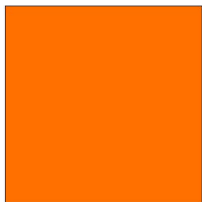

Safety Orange
(OR)

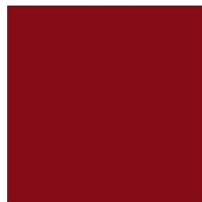

Red
(RD)

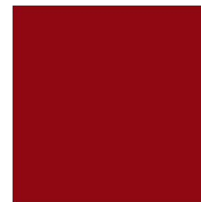

Fire Engine Red
(FR)

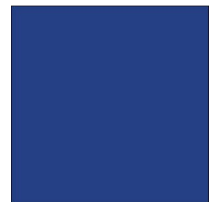

Blue
(BL)

NOTE: Factory offers any Tiger Drylac RAL finish, contact Saylite for more information. Consult factory to special order custom 'real wood' finishes.

PRODUCT DIMENSIONS

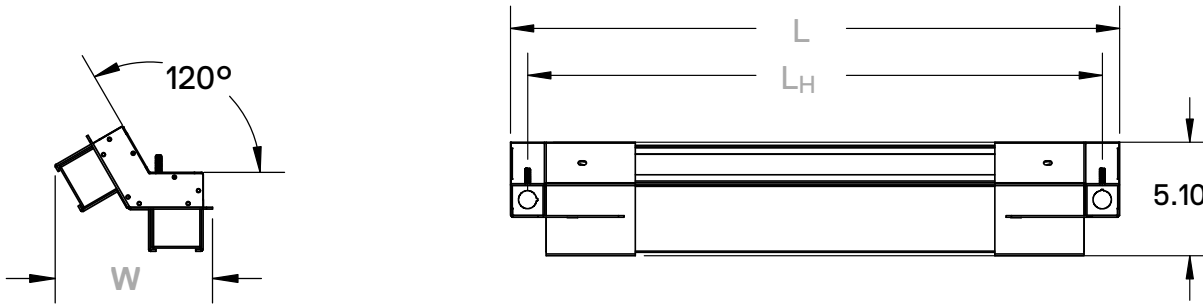

NOTE: Consult factory to alter angle of wall wash bracket.

Sample Part Number	W	L	L _H
PLY23PFR6X27LTU12D40DMVWH30KRD-WW	6.5 in.	27.334 in.	25.79 in
PLY23PFR6X51LTU24D80DMVWH30KRD-WW	6.5 in.	51.334 in.	49.79 in
PLY23PFR6X75LTU36D120DMVWH30KRD-WW	6.5 in.	75.334 in.	73.79 in
PLY23PFR6X99LTU48D160DMVWH30KRD-WW	6.5 in.	99.334 in.	97.79 in