

# Polygon 44P Series

## The Square/Rectangle

The Polygon 44P Series creates a new method for customizing the lighting in your space. Choose from multiple different bracket styles and fixture lengths to construct a unique, personalized lighting system. The popular 44P fixtures provide bright, white and energy efficient illumination with up and down lighting options. Rejuvenate your space with an interesting custom fixture!

### CONSTRUCTION

Fixture housing is welded and die-formed 22 gauge powder coated cold-rolled steel; brackets are fabricated from 18 gauge cold-rolled steel.

### OPTIONS

14W emergency battery backup integrated in fixtures 4 ft and up.

### FLAIR

Customize the color of your brackets and/or end caps to add flair to your unique hanging luminaire system. Consult factory for more information.

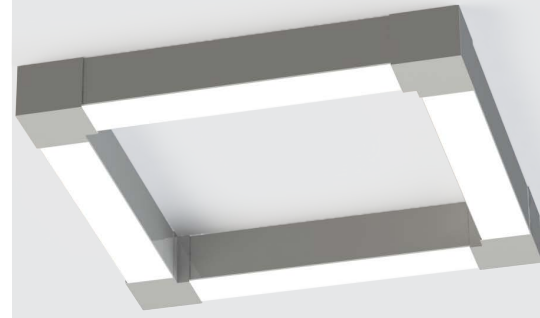

### DIMENSIONS

- 24" 44P: 34"L x 34"W x 4.05"H
- 48" 44P: 58"L x 58"W x 4.05"H
- 72" 44P: 82"L x 82"W x 4.05"H
- 96" 44P: 108"L x 108"W x 4.05"H

### SPECIFICATIONS

- 4 standard fixture sizes – 24", 48", 72", and 96"
- Customizable bracket colors available
- Pendant mount for most ceilings
- Many lumen package / wattage options via programmable drivers
- Multiple Kelvin temperature options (3000K, 3500K, 4000K, 5000K)
- Emergency battery backup options available
- CRI >80 (90 CRI available)
- >50,000 hrs of L70 LED life
- Rated for dry and damp locations
- 0-10 Volt dimmable 120-277V (120V ELV/TRIAC avail)
- Power factor >0.90
- 5 year warranty



### ORDERING GUIDE

Factory at your fingertips. Fill in the blanks to create your part number or create a custom configuration. *Sample Part Number: PLY44 -SF-58X58-LR-U112-D192-DMV-WH-30K-SL-EM14-SQ*

SERIES	DIFFUSER	WIDTH X LENGTH <sup>1</sup>	GEAR	WATTAGE & LUMENS* <sup>2</sup>	
PLY44	SF Snap-in Frosted acrylic	34X34 34"W x 34"L	LR	Up & Down	U56D96 Uplight 56W & 5600 Lumens, Downlight 96W & 9600 Lumens
					D96 Downlight 96W & 9600 Lumens
				Down Only	U112D192 Uplight 112W & 11200 Lumens, Downlight 192W & 19200 Lumens
					D192 Downlight 192W & 19200 Lumens
		58X58 58"W x 58"L	LR	Up & Down	U168D288 Uplight 168W & 16800 Lumens, Downlight 288W & 28800 Lumens
					D288 Downlight 288W & 28800 Lumens
				Down Only	U224D384 Uplight 224W & 22400 Lumens, Downlight 384W & 38400 Lumens
					D384 Downlight 384W & 38400 Lumens
		82X82 82"W x 82"L	LR	Up & Down	U168D288 Uplight 168W & 16800 Lumens, Downlight 288W & 28800 Lumens
					D288 Downlight 288W & 28800 Lumens
				Down Only	U224D384 Uplight 224W & 22400 Lumens, Downlight 384W & 38400 Lumens
					D384 Downlight 384W & 38400 Lumens
108X108 108"W x 108"L	LR	Up & Down	U168D288 Uplight 168W & 16800 Lumens, Downlight 288W & 28800 Lumens		
			D288 Downlight 288W & 28800 Lumens		
		Down Only	U224D384 Uplight 224W & 22400 Lumens, Downlight 384W & 38400 Lumens		
			D384 Downlight 384W & 38400 Lumens		

DRIVER		FINISH		CCT		FLAIR <sup>3</sup>		OPTIONS	
DMV	0-10V Dimming	WH	White	30K	3000K	SL	Silver	EMERGENCY	
		BK	Black	35K	3500K	BK	Black	EM14	14W Emergency battery backup (integrated in fixtures 4ft and over)
DMV11	0-10V Dimming Separate drivers for uplight and downlight	SL	Silver	40K	4000K	RD	Red		
				50K	5000K				

**Note:**

- Width and length measured as overall system dimensions, dimensions will change for each custom pattern created.
- Values shown are per fixture. Minimum fixture wattage of 10W. Minimum 5W per fixture foot uplight and downlight. Maximum 9W per fixture foot uplight and 18W per fixture foot downlight. Power feed cable is 18AWG, power drop is required every 800W or 48 feet for 1-10V dimming, whichever comes first. EM not available in fixtures with sections 2' and shorter if there is uplight and downlight.
- NEW! Personalize your lighting even further by choosing a standard flair color for your brackets, at no additional cost, from the guide on the following page.
- Create your own custom pattern to fit your space! All custom patterns require design and drawing approval, contact factory for more information.
- HC712 hanging kit comes standard with PLY44 fixtures. Consult factory for other options.

\*Programmable LED drivers allow custom configured wattages and corresponding lumens.

We reserve the right to change design, materials, LED's and finish in any way that will not alter installed appearance or reduce function and performance.

CATALOG#: \_\_\_\_\_  
PROJECT: \_\_\_\_\_  
TYPE: \_\_\_\_\_

## STANDARD FLAIR BRACKET COLORS AND FINISHES

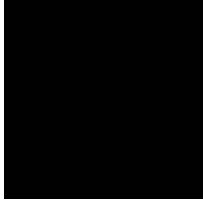

Gloss Black  
(GB)

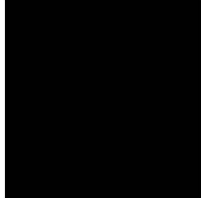

Matte Black  
(BK)



Matte Silver  
(SL)



Statuary Bronze  
(BZ)

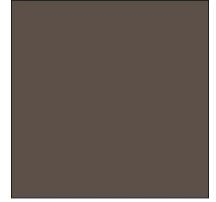

Glimmer (Iron)  
(IR)

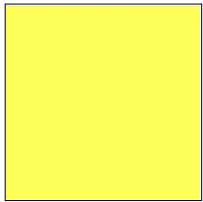

Safety Yellow  
(YL)



Safety Orange  
(OR)

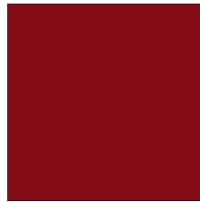

Red  
(RD)

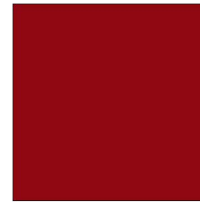

Fire Engine Red  
(FR)

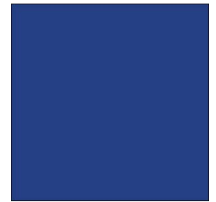

Blue  
(BL)

**NOTE:** Factory offers any Tiger Drylac RAL finish, contact Saylite for more information. Consult factory for information on specialty "real wood" finishes.

CATALOG#: \_\_\_\_\_  
PROJECT: \_\_\_\_\_  
TYPE: \_\_\_\_\_

# Polygon 44P Series

## Geometric 44P Pendant Bracket System

### PRODUCT DIMENSIONS

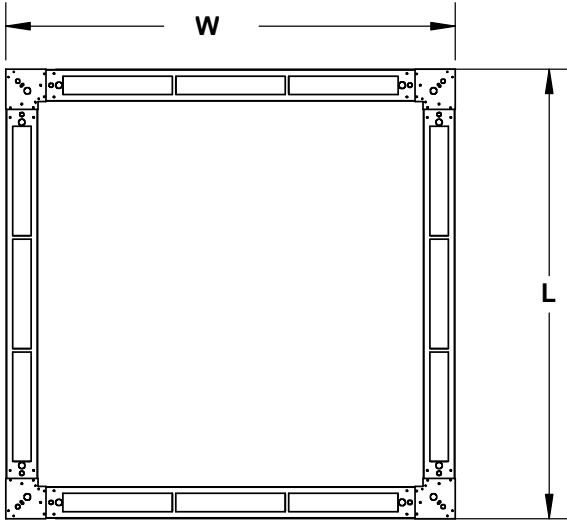

Sample Part Number	W	L
PLY44SF34X34LRU56D96DMVWH30KBK-SQ	34 in.	34 in.
PLY44SF58X58LRU112D192DMVWH30KBK-SQ	58 in.	58 in.
PLY44SF82X82LRU168D288DMVWH30KBK-SQ	82 in.	82 in.
PLY44SF108X108LRU224D384DMVWH30KBK-SQ	108 in.	108 in.

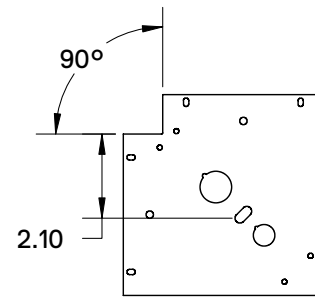

90° Bracket

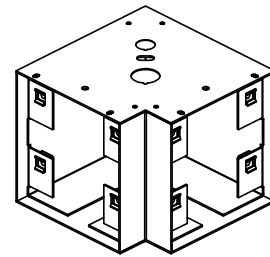

# Polygon 44P Series

## The Hexagon

The Polygon 44P Series creates a new method for customizing the lighting in your space. Choose from multiple different bracket styles and fixture lengths to construct a unique, personalized lighting system. The popular 44P fixtures provide bright, white and energy efficient illumination with up and down lighting options. Rejuvenate your space with an interesting custom fixture!

### CONSTRUCTION

Fixture housing is welded and die-formed 22 gauge powder coated cold-rolled steel; brackets are fabricated from 18 gauge cold-rolled steel.

### OPTIONS

14W emergency battery backup integrated in fixtures 4 ft and up.

### FLAIR

Customize the color of your brackets and/or end caps to add flair to your unique hanging luminaire system. Consult factory for more information.

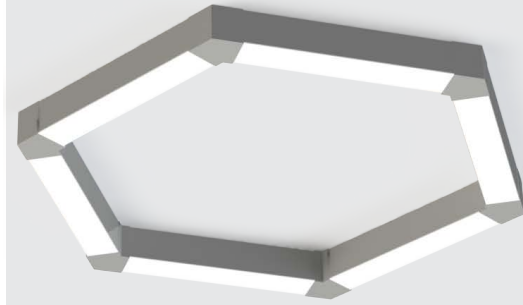

### DIMENSIONS

- 24" 44P: 61" Nominal Dia.
- 48" 44P: 108" Nominal Dia.
- 72" 44P: 156" Nominal Dia.
- 96" 44P: 204" Nominal Dia.

### SPECIFICATIONS

- 4 standard fixture sizes – 24", 48", 72", and 96"
- Customizable bracket colors available
- Pendant mount for most ceilings
- Many lumen package / wattage options via programmable drivers
- Multiple Kelvin temperature options (3000K, 3500K, 4000K, 5000K)
- Emergency battery backup options available
- CRI >80 (90 CRI available)
- >50,000 hrs of L70 LED life
- Rated for dry and damp locations
- 0-10 Volt dimmable 120-277V (120V ELV/TRIAC avail)
- Power factor >0.90
- 5 year warranty



**ORDERING GUIDE**

Factory at your fingertips. Fill in the blanks to create your part number or create a custom configuration.  
Sample Part Number: PLY44 -SF-108-LR-U168-D288-DMV-WH-30K-SL-EM14-HX

SERIES	DIFFUSER	DIAMETER <sup>1</sup>	GEAR	WATTAGE & LUMENS* <sup>2</sup>	
PLY44	SF Snap-in Frosted acrylic	61	LR	Up & Down	U84D144 Uplight 84W & 8400 Lumens, Downlight 144W & 14400 Lumens
					D144 Downlight 144W & 14400 Lumens
		108		Up & Down	U168D288 Uplight 168W & 16800 Lumens, Downlight 288W & 28800 Lumens
					D288 Downlight 288W & 28800 Lumens
		156		Up & Down	U252D432 Uplight 252W & 25200 Lumens, Downlight 432W & 43200 Lumens
					D432 Downlight 432W & 43200 Lumens
		204		Up & Down	U336D576 Uplight 336W & 33600 Lumens, Downlight 576W & 57600 Lumens
					D576 Downlight 576W & 57600 Lumens
				Down Only	

DRIVER		FINISH		CCT		FLAIR <sup>3</sup>		OPTIONS	
								EMERGENCY	CONFIGURATION
DMV	040V Dimming	WH	White	30K	3000K	SL	Silver	EM14 14W Emergency battery backup (integrated in fixtures 4ft and over)	HX Hexagon
DMV11	0-10V Dimming Separate drivers for uplight and downlight	BK	Black	35K	3500K	BK	Black		
		SL	Silver	40K	4000K	RD	Red		
				50K	5000K				

**Note:**

- Width and length measured as overall system diameter, dimensions will change for each custom pattern created.
- Values shown are per fixture. Minimum fixture wattage of 10W. Minimum 5W per fixture foot uplight and downlight. Maximum 9W per fixture foot uplight and 18W per fixture foot downlight. Power feed cable is 18AWG, power drop is required every 800W or 48 feet for 1-10V dimming, whichever comes first. EM not available in fixtures with sections 2' and shorter if there is uplight and downlight.
- NEW! Personalize your lighting even further by choosing a standard flair color for your brackets, at no additional cost, from the guide on the following page.
- Create your own custom pattern to fit your space! All custom patterns require design and drawing approval, contact factory for more information.
- HC712 hanging kit comes standard with PLY44 fixtures. Consult factory for other options.

\*Programmable LED drivers allow custom configured wattages and corresponding lumens.

We reserve the right to change design, materials, LED's and finish in any way that will not alter installed appearance or reduce function and performance.

CATALOG#: \_\_\_\_\_  
PROJECT: \_\_\_\_\_  
TYPE: \_\_\_\_\_

## STANDARD FLAIR BRACKET COLORS AND FINISHES



Gloss Black  
(GB)



Matte Black  
(BK)



Matte Silver  
(SL)

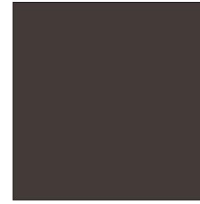

Statuary Bronze  
(BZ)



Glimmer (Iron)  
(IR)

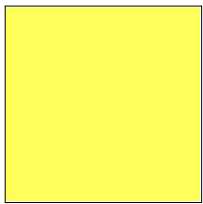

Safety Yellow  
(YL)

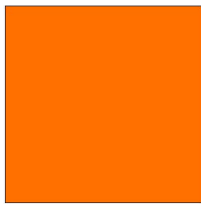

Safety Orange  
(OR)

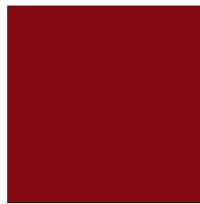

Red  
(RD)

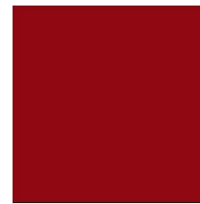

Fire Engine Red  
(FR)



Blue  
(BL)

**NOTE:** Factory offers any Tiger Drylac RAL finish, contact Saylite for more information. Consult factory for information on specialty "real wood" finishes.

CATALOG#: \_\_\_\_\_  
PROJECT: \_\_\_\_\_  
TYPE: \_\_\_\_\_

# Polygon 44P Series

## Geometric 44P Pendant Bracket System

### PRODUCT DIMENSIONS

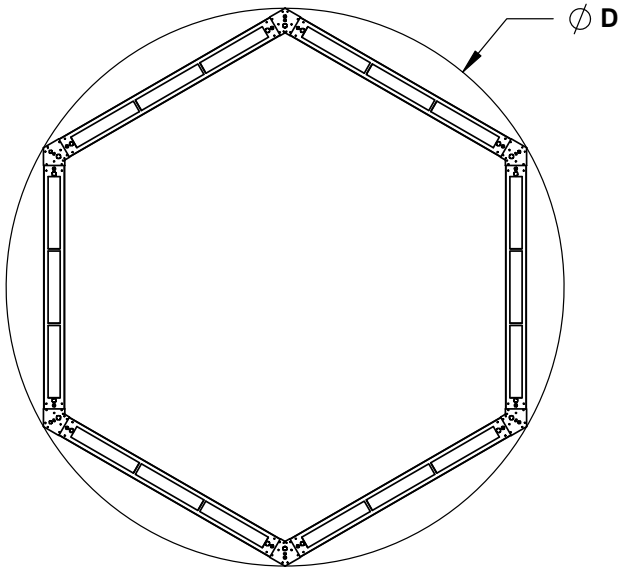

Sample Part Number	Diameter
PLY44SF61LRU84D144DMVWH30KBK-HX	61 in.
PLY44SF108LRU168D288DMVWH30KBK-HX	108 in.
PLY44SF156LRU252D432DMVWH30KBK-HX	156 in.
PLY44SF204LRU336D576DMVWH30KBK-HX	204 in.

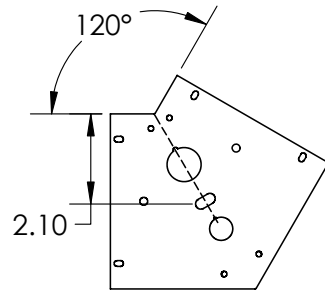

120° Bracket

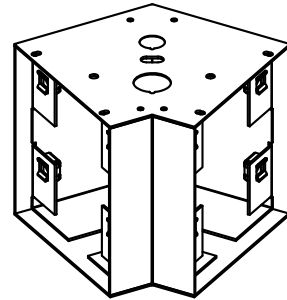



# Polygon 44P Series

## The Octagon

The Polygon 44P Series creates a new method for customizing the lighting in your space. Choose from multiple different bracket styles and fixture lengths to construct a unique, personalized lighting system. The popular 44P fixtures provide bright, white and energy efficient illumination with up and down lighting options. Rejuvenate your space with an interesting custom fixture!

### CONSTRUCTION

Fixture housing is welded and die-formed 22 gauge powder coated cold-rolled steel; brackets are fabricated from 18 gauge cold-rolled steel.

### OPTIONS

14W emergency battery backup integrated in fixtures 4 ft and up.

### FLAIR

Customize the color of your brackets and/or end caps to add flair to your unique hanging luminaire system. Consult factory for more information.

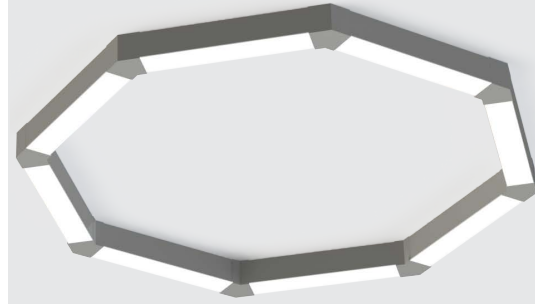

### DIMENSIONS

24" 44P: 77" Nominal Dia.  
48" 44P: 140" Nominal Dia.  
72" 44P: 203" Nominal Dia.  
96" 44P: 265" Nominal Dia.

### SPECIFICATIONS

- 4 standard fixture sizes – 24", 48", 72", and 96"
- Customizable bracket colors available
- Pendant mount for most ceilings
- Many lumen package / wattage options via programmable drivers
- Multiple Kelvin temperature options (3000K, 3500K, 4000K, 5000K)
- Emergency battery backup options available
- CRI >80 (90 CRI available)
- >50,000 hrs of L70 LED life
- Rated for dry and damp locations
- 0-10 Volt dimmable 120-277V (120V ELV/TRIAC avail)
- Power factor >0.90
- 5 year warranty



### ORDERING GUIDE

Factory at your fingertips. Fill in the blanks to create our part number or create a custom configuration.  
 Sample Part Number: PLY44 -SF-77-LR-U112-D192-DMV-WH-30K-SL-EM14-OT

SERIES	DIFFUSER	DIAMETER <sup>1</sup>	GEAR	WATTAGE & LUMENS* <sup>2</sup>			
PLY44	SF Snap-in Frosted acrylic	77	77" Dia.	LR	Up & Down U112D192 Uplight 112W & 11200 Lumens, Downlight 192W & 19200 Lumens		
					Down Only D192 Downlight 192W & 19200 Lumens		
				140	140" Dia.	LR	Up & Down U224D384 Uplight 224W & 22400 Lumens, Downlight 384W & 38400 Lumens
							Down Only D384 Downlight 384W & 38400 Lumens
		203	203" Dia.	LR	Up & Down U336D576 Uplight 336W & 33600 Lumens, Downlight 576W & 57600 Lumens		
					Down Only D576 Downlight 576W & 57600 Lumens		
		265	265" Dia.	LR	Up & Down U448D768 Uplight 448W & 44800 Lumens, Downlight 768W & 76800 Lumens		
					Down Only D768 Downlight 768W & 76800 Lumens		

DRIVER		FINISH		CCT		FLAIR <sup>3</sup>		OPTIONS	
DMV	040V Dimming	WH	White	30K	3000K	SL	Silver	EM14	14W Emergency battery backup (integrated in fixtures 4ft and over)
		BK	Black	35K	3500K	BK	Black		
DMV11	0-10V Dimming Separate drivers for uplight and downlight	SL	Silver	40K	4000K	RD	Red		
				50K	5000K				
								OT	Octagon

Note:

1. Width and length measured as overall system diameter, dimensions will change for each custom pattern created.
2. Values shown are per fixture. Minimum fixture wattage of 10W. Minimum 5W per fixture foot uplight and downlight. Maximum 9W per fixture foot uplight and 18W per fixture foot downlight. Power feed cable is 18AWG, power drop is required every 800W or 48 feet for 0-10V dimming, whichever comes first. EM not available in fixtures with sections 2' and shorter if there is uplight and downlight. Two power drops required when 96" fixtures are chosen.
3. NEW! Personalize your lighting even further by choosing a standard flair color for your brackets, at no additional cost, from the guide on the following page.
4. Create your own custom pattern to fit your space! All custom patterns require design and drawing approval, contact factory for more information.
5. HC712 hanging kit comes standard with PLY44 fixtures. Consult factory for other options.

\*Programmable LED drivers allow custom configured wattages and corresponding lumens.

We reserve the right to change design, materials, LED's and finish in any way that will not alter installed appearance or reduce function and performance.

CATALOG#: \_\_\_\_\_  
PROJECT: \_\_\_\_\_  
TYPE: \_\_\_\_\_

## STANDARD FLAIR BRACKET COLORS AND FINISHES

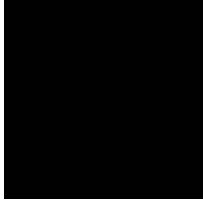

Gloss Black  
(GB)

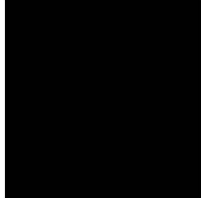

Matte Black  
(BK)



Matte Silver  
(SL)



Statuary Bronze  
(BZ)

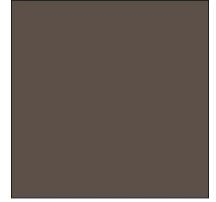

Glimmer (Iron)  
(IR)

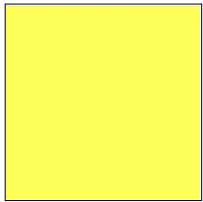

Safety Yellow  
(YL)



Safety Orange  
(OR)

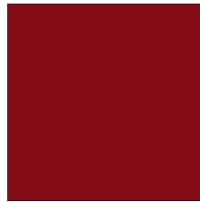

Red  
(RD)

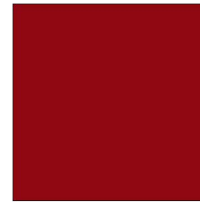

Fire Engine Red  
(FR)

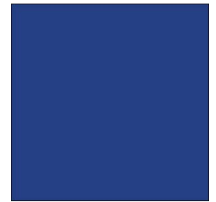

Blue  
(BL)

**NOTE:** Factory offers any Tiger Drylac RAL finish, contact Saylite for more information. Consult factory for information on specialty "real wood" finishes.

CATALOG#: \_\_\_\_\_  
PROJECT: \_\_\_\_\_  
TYPE: \_\_\_\_\_

# Polygon 44P Series

## Geometric 44P Pendant Bracket System

### PRODUCT DIMENSIONS

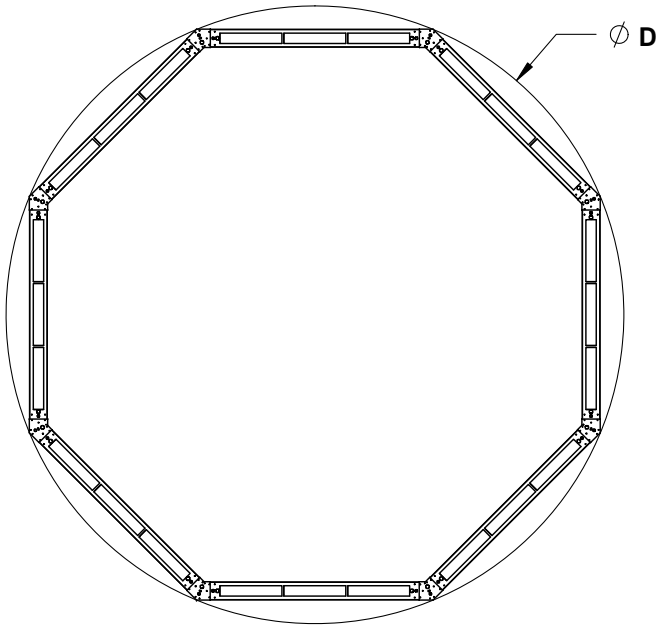

Sample Part Number	Diameter
PLY44SF77LRU112D192DMVWH30KBK-OT	77 in.
PLY44SF140LRU224D384DMVWH30KBK-OT	140 in.
PLY44SF203LRU336D576DMVWH30KBK-OT	203 in.
PLY44SF265LRU448D768DMVWH30KBK-OT	265 in.

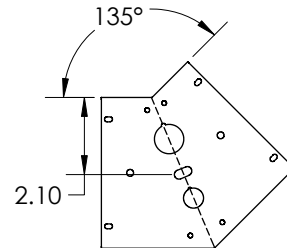

135° Bracket

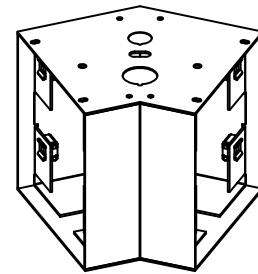

# Polygon 44P Series

## Custom

The Polygon 44P Series creates a new method for customizing the lighting in your space. Choose from multiple different bracket styles and fixture lengths to construct a unique, personalized lighting system. The popular 44P fixtures provide bright, white and energy efficient illumination with up and down lighting options. Rejuvenate your space with an interesting custom fixture!

### CONSTRUCTION

Fixture housing is welded and die-formed 22 gauge powder coated cold-rolled steel; brackets are fabricated from 18 gauge cold-rolled steel.

### OPTIONS

14W emergency battery backup integrated in fixtures 4 ft and up.

### FLAIR

Customize the color of your brackets and/or end caps to add flair to your unique hanging luminaire system. Consult factory for more information.

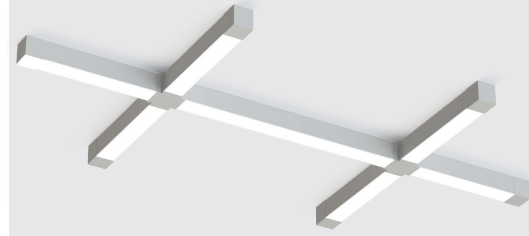

### DIMENSIONS

24" 44P: 24"L x 4"W x 4.05"H  
48" 44P: 48"L x 4"W x 4.05"H  
72" 44P: 72"L x 4"W x 4.05"H  
96" 44P: 96"L x 4"W x 4.05"H

### SPECIFICATIONS

- 4 standard fixture sizes – 24", 48", 72", and 96"
- 2 standard patterns with custom patterns available
- Customizable bracket colors available
- Pendant mount for most ceilings
- Many lumen package / wattage options via programmable drivers
- Multiple Kelvin temperature options (3000K, 3500K, 4000K, 5000K)
- Emergency battery backup options available
- CRI >80 (90 CRI available)
- >50,000 hrs of L70 LED life
- Rated for dry and damp locations
- 0-10 Volt dimmable 120-277V (120V ELV/TRIAC avail)
- Power factor >0.90
- 5 year warranty



**CONFIGURATION PATTERNS\***

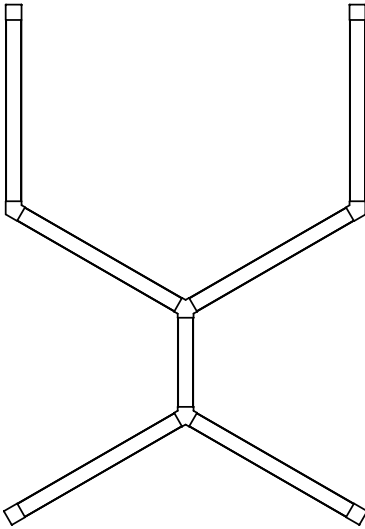

C01 - Pattern 01

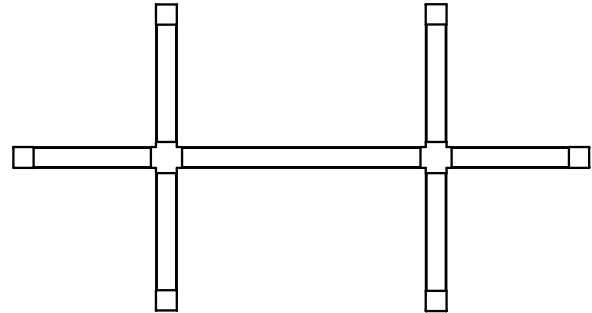

C02 - Pattern 02

**\*NOTE:** The patterns above are examples, please consult the factory to design your own custom pattern. All custom patterns require design and drawing approval.

**PRODUCT DIMENSIONS**  
Bracket Dimensions

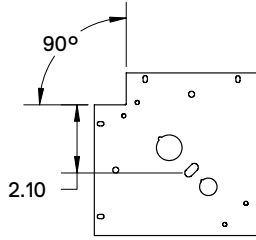

90° Bracket

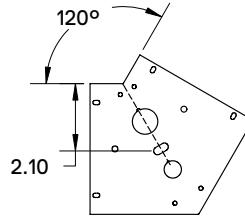
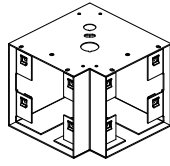

120° Bracket

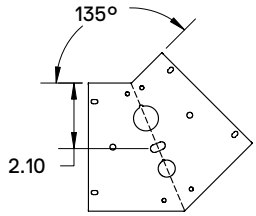
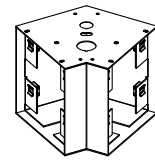

135° Bracket

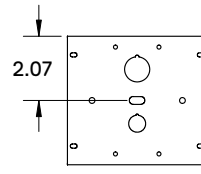
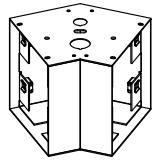

180° Bracket

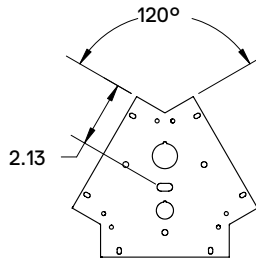
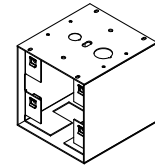

120° Y Bracket

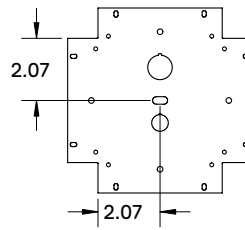
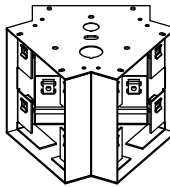

90° X Bracket

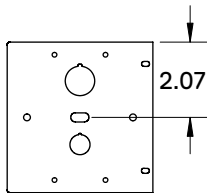
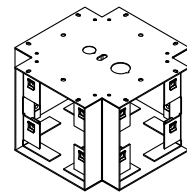

End Cap Bracket

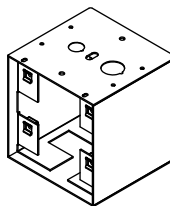

CATALOG#: \_\_\_\_\_  
PROJECT: \_\_\_\_\_  
TYPE: \_\_\_\_\_

### FLAIR BRACKET COLORS AND FINISHES



Gloss Black  
(GB)



Matte Black  
(BK)



Matte Silver  
(SL)

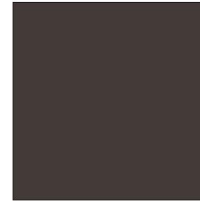

Statuary Bronze  
(BZ)

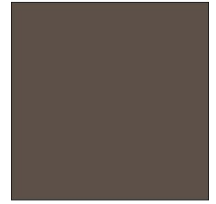

Glimmer (Iron)  
(IR)

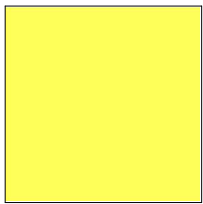

Safety Yellow  
(YL)

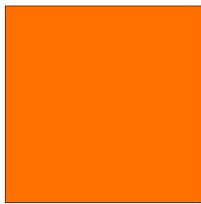

Safety Orange  
(OR)

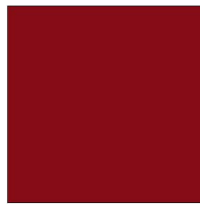

Red  
(RD)

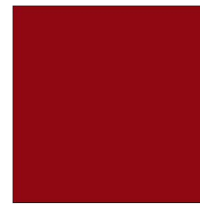

Fire Engine Red  
(FR)

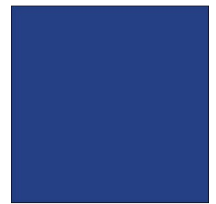

Blue  
(BL)

**NOTE:** Factory offers any Tiger Drylac RAL finish, contact Saylite for more information. Consult factory for information on specialty "real wood" finishes.