



JOB NAME:

CAT#:

TYPE:

APPLICATIONS

Extend the realm of your lighting capabilities with the The Configure Series. Specially designed brackets are used to create suspended LED flat panel systems, that work well in office or retail environments. Create interesting, decorative shapes that can mimic skylights or be arranged in elaborate, linking mobile-type patterns.

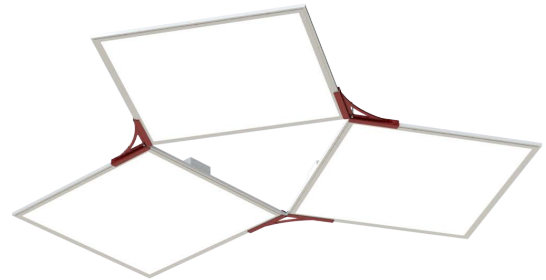

FEATURES & BENEFITS

- 3 standard panel sizes – 2'x2', 1'x4', and 2'x4'
- Customizable bracket colors available
- Pendant mount for most ceilings
- Many lumen package / wattage options via programmable drivers
- CRI >80
- >50,000 hrs of L70 LED life
- Power factor >0.90

DIMENSIONS

Part	W	L	W ₂	L ₂
2'x2' Panel	23.75"	23.75"	7.5"	0.4"
1'x4' Panel	99"	47.75"	3.75"	7.125"
2'x4' Panel	147"	47.75"	9.625"	0.3"

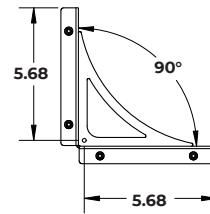
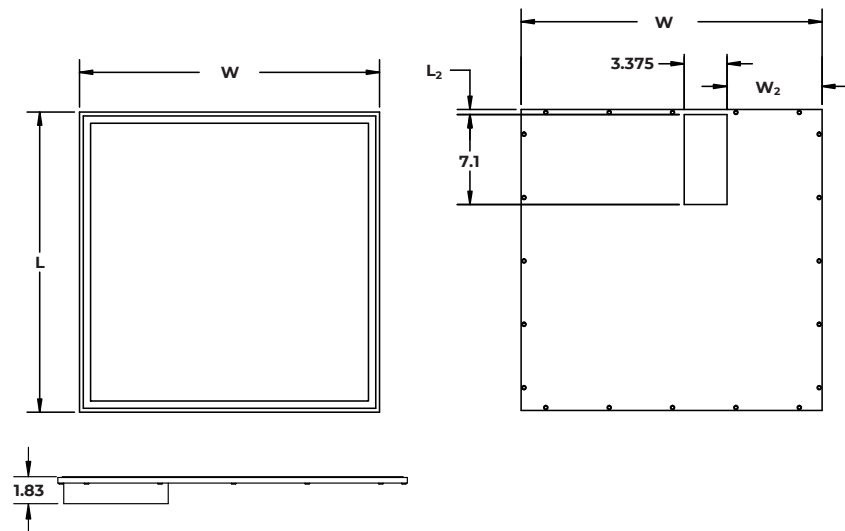

90° Bracket

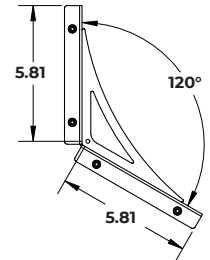

120° Bracket

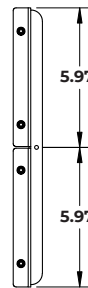

180° Bracket

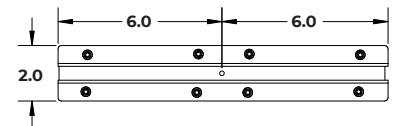

180° Double-Sided Bracket

Dimensions and specifications subject to change without notice.





JOB NAME:

CAT#:

TYPE:

ORDERING

EXAMPLE: MFPCS P 57X66 LED 120 DMV 30 RD EM -C01

MFPCS		P		LED		6. DRIVER	
1. SERIES	2. MOUNTING	3. WIDTH X LENTH ¹		4. GEAR	5. WATTAGE/LUMENS ²		6. DRIVER
MFPCS	P Pendant	57X66	57"W x 66"L	LED		-C01	DMV 120-277V
		48X48	48"W x 48"L		120	120 Watts 15000 Lumens	Multivolt
		60X60	60"W x 60"L			-C02	0-10V
					160	160 Watts 20000 Lumens	Dimmable
						-C03	
					160	160 Watts 20000 Lumens	

7. COLOR TEMP		8. FLAIR ³		9. EM (O) ⁵		10. CONFIGURATION	
30	3000K	RD	Red	EM	10W Emergency	-C01	2x2 Triangular
35	3500K	BL	Blue		Battery	-C02	2x2 Square
40	4000K	BK	Matte		Backup ⁴	-C03	1x4 Square
50	5000K		Black			-C04	2x4 Square

Notes:

¹MFPCS configurations and patterns are measured by overall system width and length. Hanging kits come with 5' aircraft cables. Consult factory for other options.

²Wattage and lumen values are total for the system. Values will vary with each custom pattern.

³Consult for custom flair options

⁴Consult factory for other emergency options

⁵(O) is optional

Dimensions and specifications subject to change without notice.



JOB NAME:

CAT#:

TYPE:

PATTERN OPTIONS

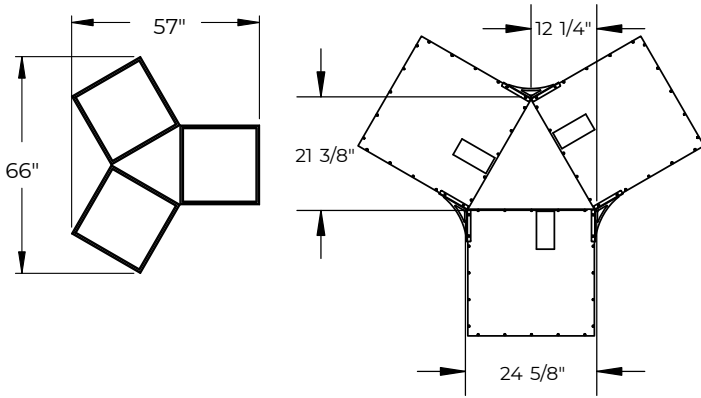

01- 2X2
Triangular Array

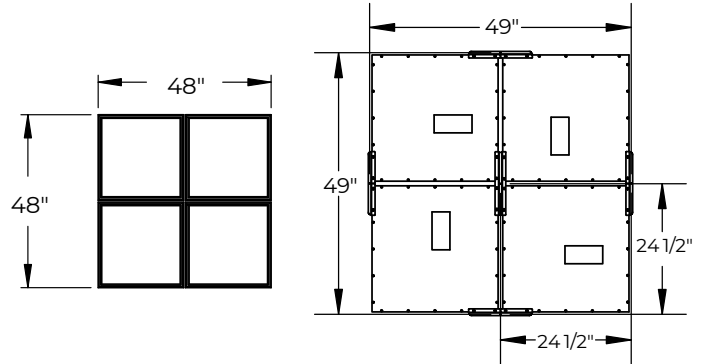

02 - 2X2 Square

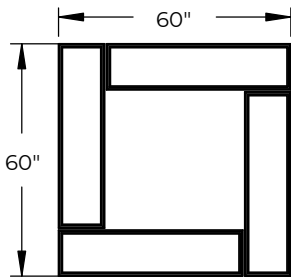

03 - 1X4 Square

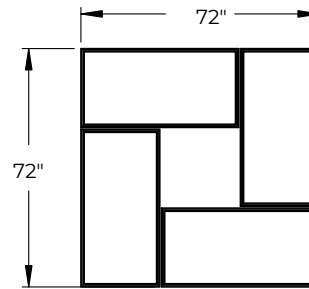

04 - 2X4 Square

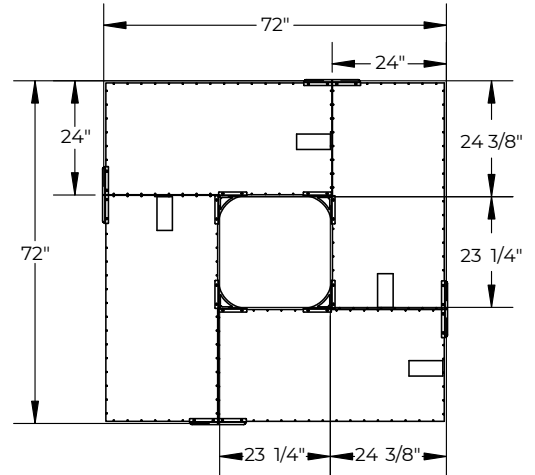
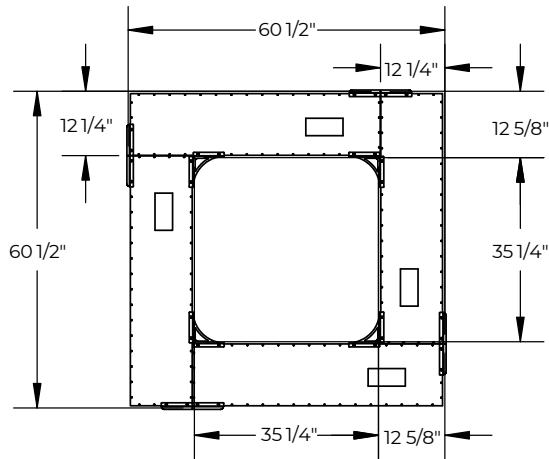

***NOTE: The custom patterns shown are examples. To create your own pattern, please consult the factory. All custom patterns must have design and drawing approval.**

Dimensions and specifications subject to change without notice.



JOB NAME:

CAT#:

TYPE:

EXAMPLE PATTERNS

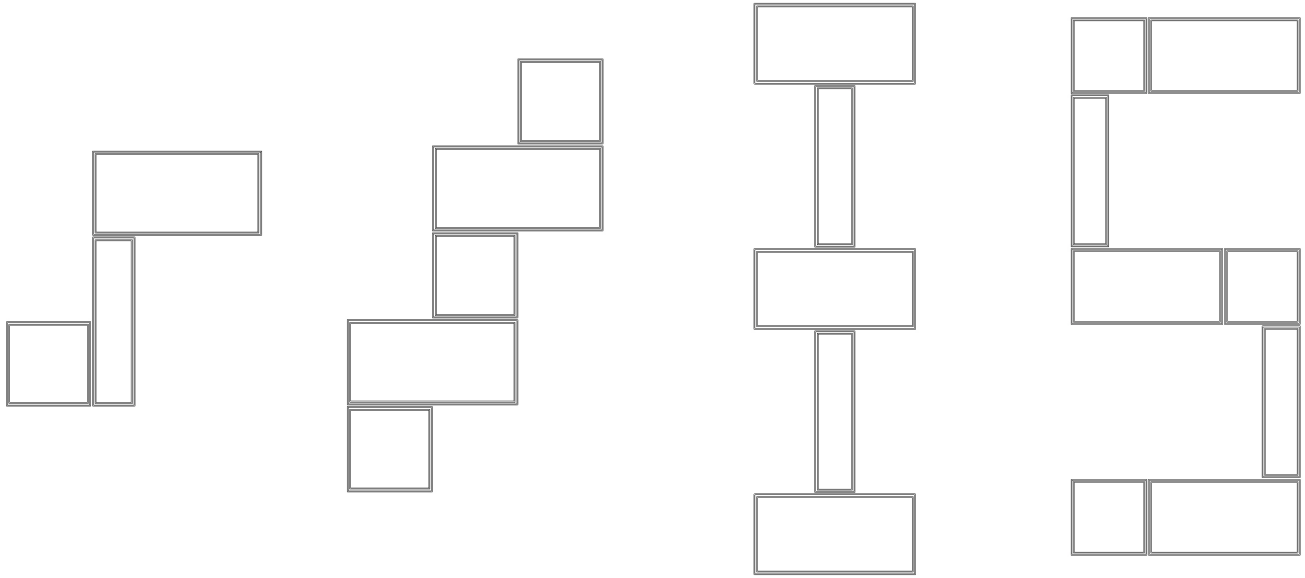

***NOTE: The custom patterns shown are examples. To create your own pattern, please consult the factory. All custom patterns must have design and drawing approval.**

Dimensions and specifications subject to change without notice.



JOB NAME:

CAT#:

TYPE:

FLAIR BRACKET COLORS AND FINISHES



Gloss Black
(GB)



Matte Black
(BK)

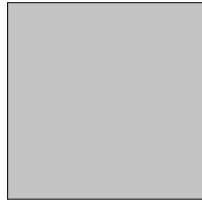

Matte Silver
(SL)



Statuary Bronze
(BZ)

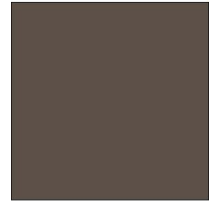

Glimmer (Iron)
(IR)

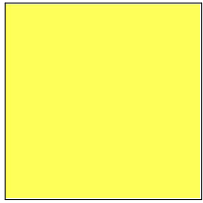

Safety Yellow
(YL)

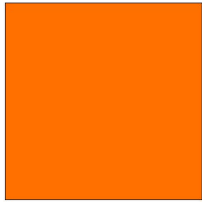

Safety Orange
(OR)



Red
(RD)



Fire Engine Red
(FR)



Blue
(BL)

NOTE: Factory offers any Tiger Drylac RAL finish, contact Saylite for more information. Consult factory for information on specialty "real wood" finishes.

Dimensions and specifications subject to change without notice.