



JOB NAME:

CAT#:

TYPE:

### APPLICATIONS

Introducing a new eye catching high efficiency LED light fixture with a narrow acoustic baffle made of sound absorbing material. Class A fire rating option available. It integrates lighting and an acoustic solution into one customizable product. The acoustic material helps create a beautiful and highly functional acoustic baffled ceiling installation. It can be combined with unlit baffles or it can be used as a stand-alone acoustic fixture. Offering multiple colors for different applications or mixing colors to create a dynamic look. Pair LED light fixture with acoustic baffles in the same or complimentary colors. Available in 1ft increments up to 8ft in length and various heights from 12" to 24". The LED light fixture slightly regressed into the acoustic housing for great lighting effect. Consult for noise reduction coefficient (NRC). For more lighting information please see the L23 series

### FEATURES & BENEFITS

- 30+ acoustic material colors available
- Pendant mount accommodates most ceiling types
- CRI >80 (90 CRI available)
- >50,000 hrs of L70 LED life
- 0-10 Volt dimmable 120-277V
- Power factor >0.90
- 5 year warranty

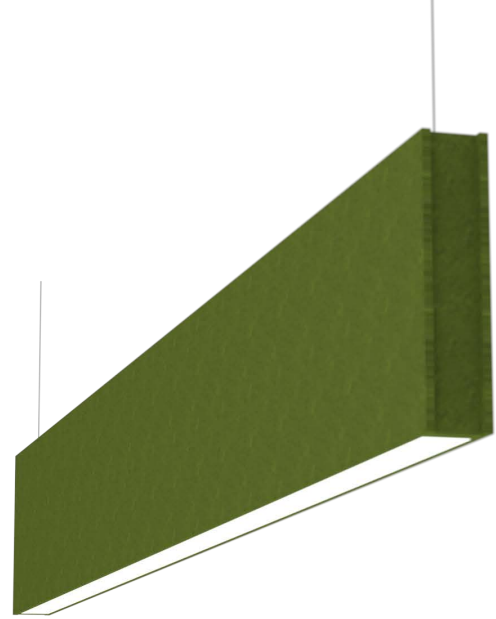

Dimensions and specifications subject to change without notice.





JOB NAME:

CAT#:

TYPE:

**ORDERING**

EXAMPLE: ABL3 24 16 LED U 23 DMV A52 W 30 EM

**ABL3**

**LED**

1. SERIES	2. LENGTH	3. HEIGHT	4. GEAR	5. DISTRIBUTION	6. WATTAGE/LUMENS	7. DRIVER	8. FLAIR A <sup>2</sup>	
<b>ABL3</b>	<b>24</b> 24"	<b>12</b> 12"	<b>LED</b>	<b>Blank</b> Downlight (std.)	<b>Downlight or Uplight Only</b>		<b>DMV</b> 120-277V Multivolt 0-10V Dimmable	<b>A44</b> Ivory <b>A19</b> Denim <b>A11</b> Steel
	<b>48</b> 48"	<b>16</b> 16"			<b>24 in.</b>			
	<b>72</b> 72"	<b>24</b> 24"			<b>12</b> 12 Watts 1320 Lumens			
	<b>96</b> 96"				<b>24</b> 24 Watts 2640 Lumens			
			<b>1U1D</b> Uplight and Downlight	<b>48 in.</b>		<b>D120</b> Triac Dimming 120VAC		
			<b>1U2D</b> Uplight and Downlight	<b>24</b> 24 Watts 2640 Lumens				
			<b>U</b> Uplight	<b>48</b> 48 Watts 5290 Lumens				
				<b>72 in.</b>				
					<b>36</b> 36 Watts 3960 Lumens			
					<b>72</b> 72 Watts 7920 Lumens			
					<b>96 in.</b>			
					<b>52</b> 52 Watts 5720 Lumens			
					<b>96</b> 96 Watts 10560 Lumens			
					<b>1 Up and 1 Down Only</b>			
					<b>48 in.</b>			
					<b>10</b> 10 Watts 500U-500D			
					<b>1 Up and 2 Down Only</b>			
					<b>24 in.</b>			
					<b>18</b> 18 Watts 660U-1320D			
					<b>27</b> 27 Watts 990U-1980D			
					<b>48 in.</b>			
					<b>36</b> 36 Watts 1320U-2640D			
					<b>54</b> 54 Watts 1980U-3960D			
					<b>72 in.</b>			
					<b>54</b> 54 Watts 1980U-3960D			
					<b>81</b> 81 Watts 2970U-5940D			
					<b>96 in.</b>			
					<b>72</b> 72 Watts 2640U-5280D			
					<b>108</b> 108 Watts 3960U-7920D			

9. FLAIR B <sup>2</sup>	10. MATERIAL CLASS	11. CRI	12. COLOR TEMP	13. EM (O) <sup>5</sup>	14. HANGING KIT (O) <sup>5</sup>
<b>Blank</b> Regressed	<b>Blank</b> Class B	<b>Blank</b> 80	<b>30</b> 3000K	<b>EM</b> Emergency Battery Backup <sup>3</sup>	<b>HC605WH</b> Cable kit with 6' cable & 5 wires power feed/cable incl., clear cord and white canopy
<b>W</b> Wood Ends	<b>A</b> Class A	<b>9</b> 90	<b>35</b> 3500K		
<b>M</b> Metal Seam			<b>40</b> 4000K		
			<b>50</b> 5000K		
					<b>HC605WHNPF</b> Cable kit with 6' cable & white canopy, non power feed
					<b>HC612WH</b> Cable kit with 12' cable & 5 wires power feed/cable incl., clear cord and white canopy
					<b>HC612WHNPF</b> Cable kit with 12' cable & white canopy, non power feed



JOB NAME:

CAT#:

TYPE:

**ACOUSTIC MATERIAL COLOR OPTIONS**



07 - White



44 - Ivory



42 - Cream



52 - Latte



02 - Taupe

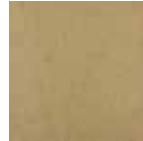

53 - Smoky  
Beige



09 - Deep  
Blue



21 - Indigo  
Blue



19 - Denim



56 - Azure



30 - Blue



18 - Arctic Ice



54 - Espresso

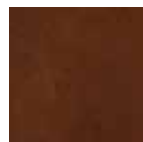

49 - Brunette



35 - Speckled  
Earth

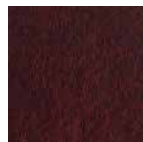

43 - Lava



36 - Berry



45 - Big Red



55 - Tangerine



41 - Marigold



50 - Caramel



51 - Sunkist  
Orange



22 - Yellow



10 - True  
Black



17- Dark  
Gray



11 - Steel



34 - Pure  
Gray



06-12-City  
Brown



03-12-  
Light Gray

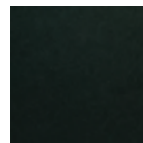

47 - Emerald



05 - Dark  
Green



12 - Moss



39 - Green  
Apple



48 - Avocado



08 - Eggplant

Dimensions and specifications subject to change without notice.



JOB NAME:

CAT#:

TYPE:

**DRAWINGS & IMAGES - Direct and Indirect**

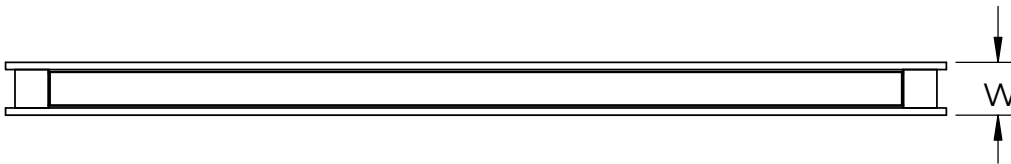
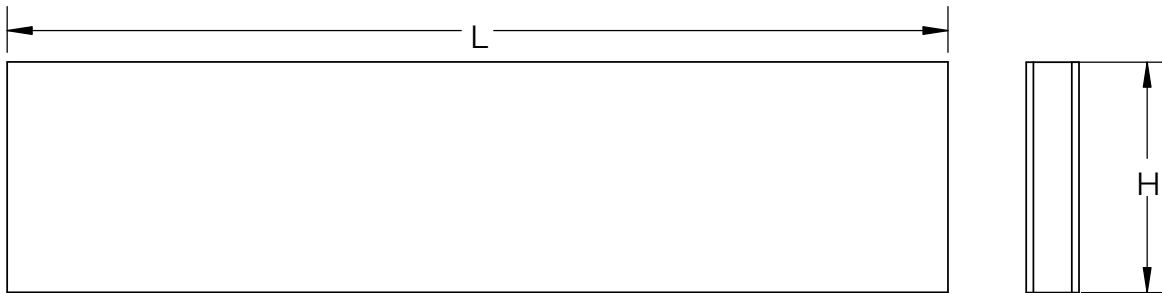

PART	L	W	H
ABL3 24	24.00"	2.75"	12",16",24"
ABL3 48	48.00"	2.75"	12",16",24"
ABL3 72	72.00"	2.75"	12",16",24"
ABL3 96	96.00"	2.75"	12",16",24"

L-Length  
W-Width  
H-Height

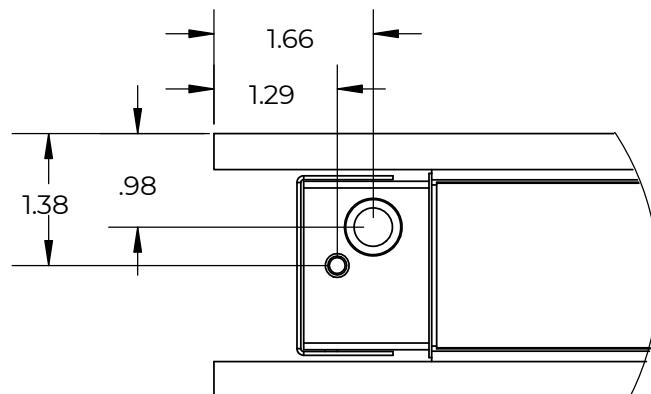

Dimensions and specifications subject to change without notice.