



JOB NAME:

CAT#:

TYPE:

APPLICATIONS

Blending together industrial design and a modern aesthetic is Mobern's Acoustic Cog Pendant. This uniquely shaped fixture is constructed from PET acoustic material that utilizes sound-absorbing technology to reduce noise in areas where echoing is prevalent. Depending on the amount of light needed for a space, choose between two lighting options (1 or 7 lamps) both of which use energy efficient LED disks. Add additional pops of color by selecting from 30+ color options to customize both the inner and outer baffles. This pendant mounted fixture is a perfect solution for lobbies, libraries, conference centers, or any open-space where modern lighting is needed.

FEATURES & BENEFITS

- 30+ acoustic material colors available
- 6' pendant mount hanging kit accommodates most ceiling types
- CRI >80 (90 CRI available)
- >50,000 hrs of L₇₀ LED life
- 0-10 Volt dimmable 120-277V
- Power factor >0.90
- 5 year warranty



DIMENSIONS

Part	L	W	H	L = Length W = Width H = Height
AGPP40X43	42.5"	39.9"	15.75"	

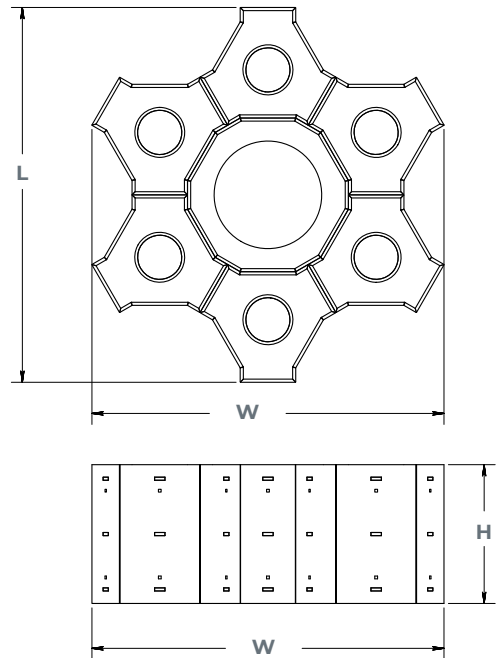
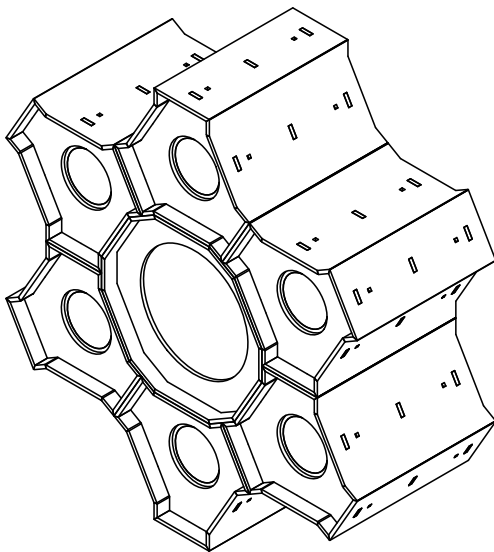

Dimensions and specifications subject to change without notice.





JOB NAME:

CAT#:

TYPE:

ORDERING

EXAMPLE: AGP P 40X43 LED 130 DMV 30 A53 A17 CO

AGP	P			LED								
1. SERIES	2. MOUNTING	3. WIDTHXLENGTH		4. GEAR	5. WATTAGE/LUMENS		6. DRIVER		7. COLOR TEMP		8. FLAIR A ¹	
AGP	P Pendant	40X43	40"W x 43"L	LED								
						<u>-C</u>	D120	120V ELV/ Triac Dimming	30	3000K	A53	Lava
					40	40 Watts 2500 Lumens					A50	Caramel
						<u>-CO</u>					A48	Avocado
					130	130 Watts 9100 Lumens						

8. FLAIR B ²		9. CONFIGURATION		10. MATERIAL CLASS	
A54	Espresso	C	Center Light Only	Blank	Class B
A55	Tangerine			A	Class A
A17	Dark Gray	CO	Center and Outer Lights		

Notes:

¹Flair A refers to the horizontal acoustic material pieces

²Flair B refers to the vertical acoustic material pieces

Dimensions and specifications subject to change without notice.



JOB NAME:

CAT#:

TYPE:

ACOUSTIC MATERIAL COLOR OPTIONS



07 - White



44 - Ivory



42 - Cream



52 - Latte



02 - Taupe



53 - Smoky
Beige



09 - Deep
Blue



21 - Indigo
Blue



19 - Denim



56 - Azure



30 - Blue



18 - Arctic Ice



54 - Espresso



49 - Brunette



35 - Speckled
Earth



43 - Lava



36 - Berry



45 - Big Red



55 - Tangerine



41 - Marigold



50 - Caramel



51 - Sunkist
Orange



22 - Yellow

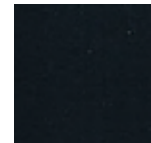

10 - True
Black



17- Dark
Gray



11 - Steel

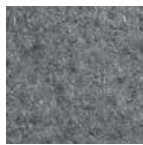

34 - Pure
Gray

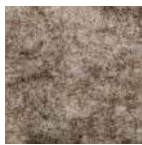

06-12-City
Brown



03-12-
Light Gray

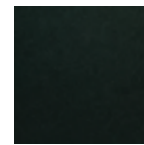

47 - Emerald

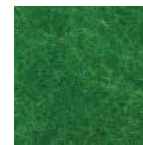

05 - Dark
Green



12 - Moss



39 - Green
Apple



48 - Avocado



08 - Eggplant

Dimensions and specifications subject to change without notice.